

SPECIFICATION

Customer : _____

Customer No.: _____

Product : _____ LCM

Product No.: CDT0177-006V1

Date : 2009/5/4



 深圳市中显示电子有限公司 CHINA DISPLAY TECHNOLOGY CO., LTD.		
APPROVED	CHECKED	PREPARED

Customer Approval	<input type="checkbox"/> Accept <input type="checkbox"/> Reject Comment: <div style="text-align: right;">Approved by: _____</div>
----------------------	--

Version	Date	Details	Note
A0	2009-5-4	Initial Release. The LCD module is RoHS compliant. This product change the PLZ base on the CDT0177-006	New Issued

Table Of Contents

Section/Sub Section	Pages	Rev.
1. General Specification	4	0
2. LCM Description	5	0
2.1 LCM Drawing	5	0
2.2 LCD Logic Diagram	6	0
3. Interface PIN Assignment	7	0
4. Absolute Maximum Rating	7	0
5. Electrical Characteristics	8	0
6. Optical Characteristics	8	0
7. Read/Write operation sequence	9	0
8. Reliability	10	0
8.1 Environmental Test	10	0
8.2 Mechanical Test	11	0
8.3 Life Time	11	0
9. Appearance Standards	11	0
9.1 Inspection Conditions	11	0
9.2 Definition of Applicable Zones	11	0
9.3 Standards	12	0
10. Precautions	14	0
10.1 Operation	14	0
10.2 Safety	14	0
10.3 Handling	14	0
10.4 Static electricity	15	0
10.5 Storage	16	0
10.6 Cleaning	16	0
10.7 Waste	16	0
11. Warranty	16	0

1. General Specification

Item	CONTENTS	Unit
Module Size	34(W) *45.83 (H) *2.75 (D)	mm
Display Format	128(RGB)*160	
LCD Driving Method	--	
LCD type	TFT/ Transmissive /Positive	
View Area(W*H)	--	mm
Active Area(W*H)	28.03*35	
View Angle	6 O'clock	mm
Controller IC	ST7735 or compatable IC	
Backlight Tpye & Color	Edge LED&White	
Interface Type	4-line SPI	
Operation Temperature	TOPL = -20, TOPH =70	°C
Storage Temperature	TSTL = -30, TSTH =80	°C

2. LCM Description

2.1 LCM Drawing

See appendix

2.2 LCD Logic Diagram

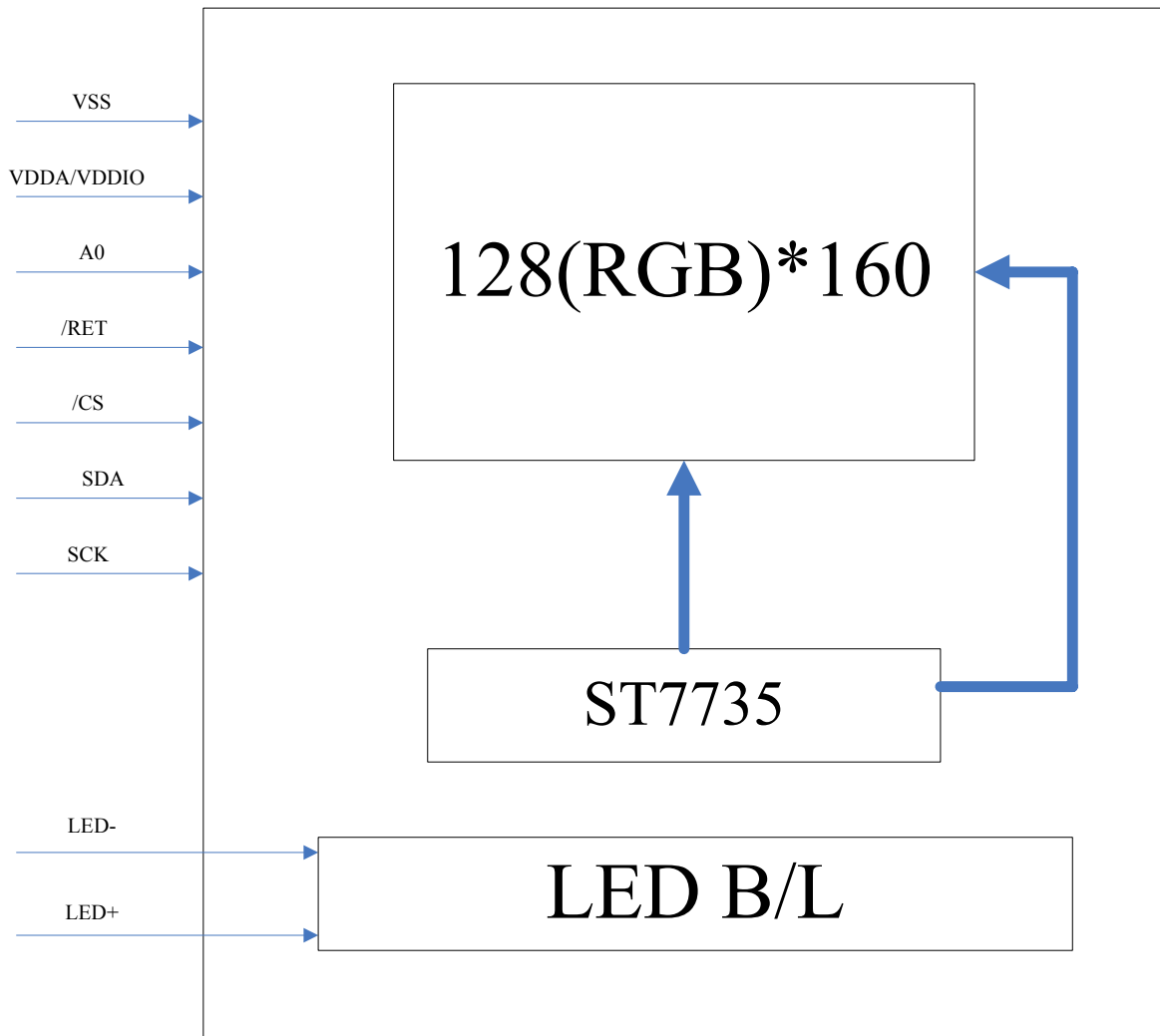

3. Interface PIN Assignment

No.	Symbol	Function
1	NC	Not connect.
2	VSS	Ground.
3	LED-	Cathode of backlight input.
4	LED+	Anode of backlight input.
5	VSS	Ground.
6	/RET	Reset input, low active.
7	A0	Select display data or control data.
8	SDA	Serial data input.
9	SCK	Serial clock input.
10	VDDA	Power supply for analog(2.8V).
11	VDDIO	Power supply for I/O system(2.8V).
12	/CS	Chip select pin.,low active.
13	VSS	Ground.
14	NC	Not connect.

4. Absolute Maximum Rating($T_a=25^{\circ}\text{C}$ VSS=0V)

Item	Symbol	Min.	Type	Max.	Unit	Humidity
Supply Voltage for Logic	VDD---VSS	-0.3	-	4.6	Volt	--
Power Supply for LCD	VGH-VGL	-0.3	--	30	Volt	--
Operating temperature	Top	-20	--	+70	$^{\circ}\text{C}$	Note1
Storage temperature	Tst	-30	--	+80	$^{\circ}\text{C}$	Note2

Note1: Background color changes slightly depending on ambient temperature. This phenomenon is reversible.

$T_a \leq 70^{\circ}\text{C}$: 75%RH max

$T_a > 50^{\circ}\text{C}$: absolute humidity must be lower than the humidity of 75%RH at 50°C

Note2: T_a at -10°C will be <48hrs, at 60°C will be <120hrs when humidity is higher than 75%RH.

$T_a \leq 60^{\circ}\text{C}$: 75%RH max

$T_a > 60^{\circ}\text{C}$: absolute humidity must be lower than the humidity of 75%RH at 60°C

5. Electrical Characteristics (Ta = 25°C)

Item	Symbol	Condition	Min.	Type	Max.	Unit
Power Supply for Logic	V _{DD} ---V _{SS}	--	--	+2.8	--	Volt
Input Voltage	V _{IL}	L level	V _{SS}	--	0.3*V _{DD}	Volt
	V _{IH}	H level	0.7*V _{DD}	--	V _{DD}	Volt
Power Supply Current for LCM	I _{DD}	V _{DD} =2.8V	--	TBD	--	mA
Power supply for LED Backlight	V _{LED}	--	---	3.2	--	Volt
Luminance (on the backlight surface)			200	-	-	cd2/m

7. Read/Write operation sequence

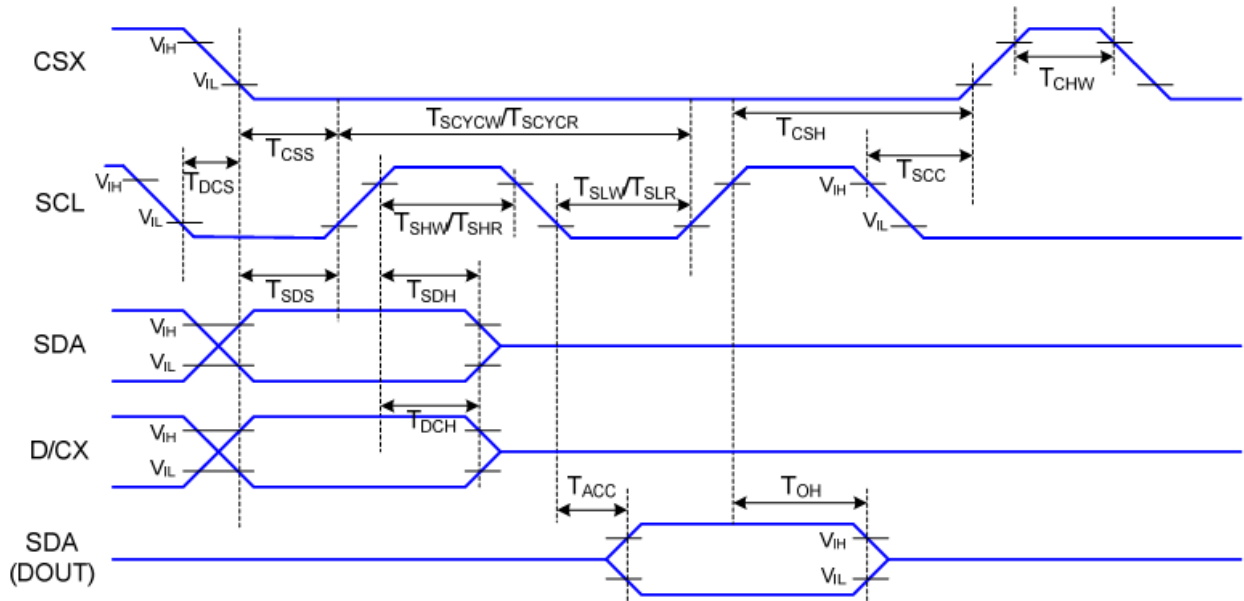

Signal	Symbol	Parameter	MIN	MAX	Unit	Description
CSX	TDCS	Chip select setup time (write)	15		ns	
	TCSH	Chip select hold time (write)	15		ns	
	TDCS	Chip select setup time (read)	60		ns	
	TSCC	Chip select hold time (read)	65		ns	
	TCHW	Chip select "H" pulse width	40		ns	
SCL	TSCYCW	Serial clock cycle (Write)	66		ns	-write command & data ram
	TSHW	SCL "H" pulse width (Write)	30		ns	
	TSLW	SCL "L" pulse width (Write)	30		ns	
	TSCYCR	Serial clock cycle (Read)	150		ns	-read command & data ram
	TSHR	SCL "H" pulse width (Read)	60		ns	
	TSLR	SCL "L" pulse width (Read)	60		ns	
D/CX	TDCS	D/CX setup time		0	ns	
	TDCH	D/CX hold time	10		ns	
SDA (DIN) (DOUT)	TSDS	Data setup time	10		ns	For maximum CL=30pF For minimum CL=8pF
	TSDH	Data hold time	10		ns	
	TACC	Access time	10	50	ns	
	TOH	Output disable time		50	ns	

Note 1: VDDI=1.65 to 3.3V, VDD=2.6 to 3.3V, AGND=DGND=0V, Ta=25 °C

Note 2: The rising time and falling time (Tr, Tf) of input signal are specified at 15 ns or less. Logic high and low levels are specified as 30% and 70% of VDDI for Input signals.

8. Reliability

8.1 Environmental Test

NO	Test Item	Test Condition	Test Time	Note
1	Low temperature storage	-30±2℃	240H	--
2	High temperature storage	80±2℃	240H	--
3	Low temperature operation	-20±2℃	96H	--
4	High temperature operation	70±2℃	96H	--
5	High temperature/ Humidity storage	60±2℃ 90%±5%RH	240H	Without dewing
6	Thermal shock storage	-20℃(30min)→25℃(5min)→+70℃ (30min)	10 cycles	--

8.2 Mechanical Test

NO.	Test Item	Test Condition	Note
1	Vibration test	Sweep for 1 min at 10Hz , 55Hz , 10Hz , amplitude 1.5mm 15 minutes each in the X , Y and Z directions (Total 45 minutes)	Non operation state
2	Drop test	One angle , three edges and six sides. 75cm above the ground(no weight difference)	Non operation state

8.3 Life Time

NO.	Description
1	Functions, Performance, appearance, etc. shall be free from remarkable deterioration within 50,000 hours under ordinary operating and storage conditions room temperature (25±10℃) , normal humidity(45±20%RH),and in area not exposed to direct sun light. (Except backlight)

9. Appearance Standards

9.1 Inspection Conditions

The LCD shall be inspected under 40W white fluorescent light. The distance between the eyes and the sample shall be more than 30cm. All directions for inspecting the sample should be within 45° against perpendicular line.

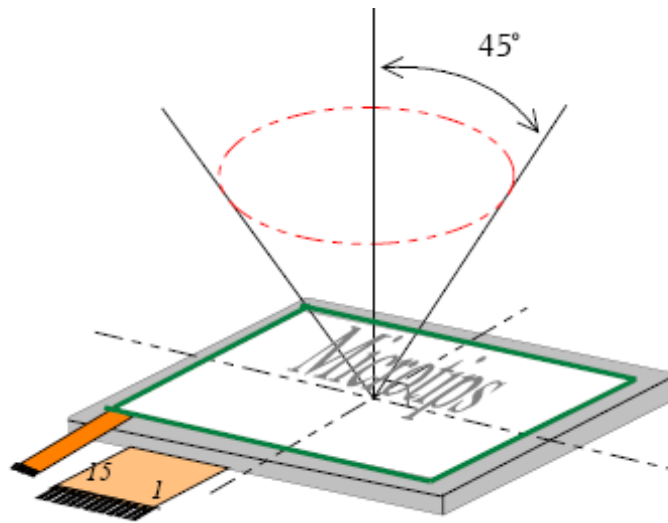

9.2 Definition of Applicable Zones

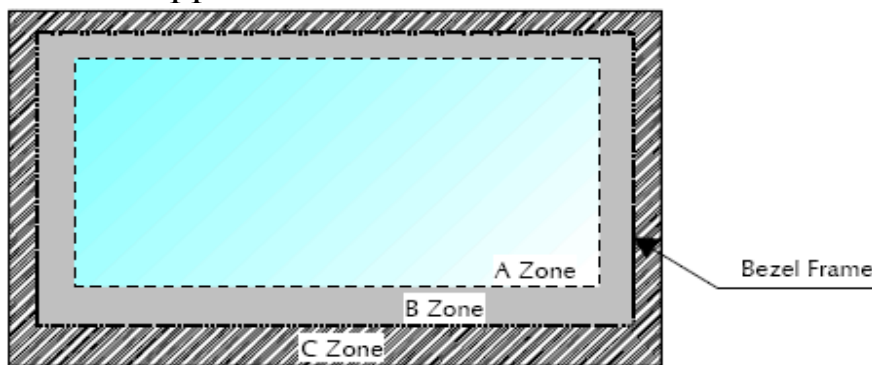

A Zone : Active display area

B Zone : Area from outside of "A Zone" to validity viewing area

C Zone : Rest parts

A Zone + B Zone = Validity viewing area

9.3 Standards

No.	Parameter	Criteria						
1.	Black and White Spots, Foreign Substances	(1) Round Shape						
		Zone			Acceptable Number			
		Dimension (mm)			A	B	C	
				D ≤ 0.2	*	*	*	
		0.2	<	D ≤ 0.3	5	6	*	
		0.3	<	D ≤ 0.5	3	4	*	
		0.5	<	D	0	1	*	
		D = (Long + Short)/2 * : Disregard						
		(2) Line Shape						
		X (mm)		Y (mm)		Acceptable Number		
						A	B	C
		-		W ≤ 0.03		*	*	*
L ≤ 2.0		0.03 < W ≤ 0.1		*	*	*		
2.0 ≤ L ≤ 4.0				3	*	*		
4.0 < L				0	2	*		
-		0.1 < W		In the same way (1)				
X : Length Y: Width * : Disregard								
2.	Air Bubbles (between glass & polarizer)	Zone			Acceptable Number			
		Dimension (mm)			A	B	C	
				D ≤ 0.3	*	*	*	
		0.3	<	D ≤ 0.4	5	*	*	
		0.4	<	D ≤ 0.6	3	3	*	
		0.6	<	D	0	0	*	
		* : Disregard						

To be continued.....

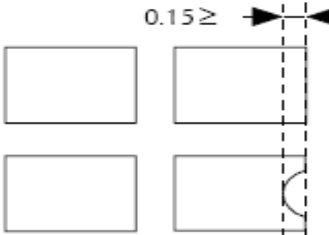
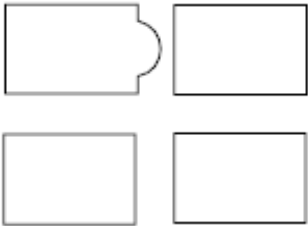
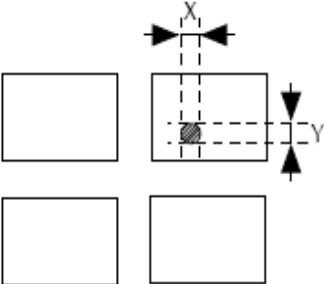
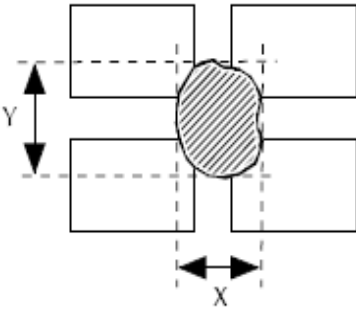
No.	Parameter	Criteria
3.	The Shape of Dot	<div style="display: flex; flex-direction: column; align-items: flex-start;"> <div style="margin-bottom: 20px;">  <p>(1) Dot Shape (with Dent)</p> <p>As per the sketch of left hand.</p> </div> <div style="margin-bottom: 20px;">  <p>(2) Dot Shape (with Projection)</p> <p>Should not be connected to next dot.</p> </div> <div style="margin-bottom: 20px;">  <p>(3) Pin Hole</p> <p>(X+Y)/2 ≤ 0.2mm (Less than 0.1mm is no counted.)</p> </div> <div style="margin-bottom: 20px;">  <p>(4) Deformation</p> <p>(X+Y)/2 ≤ 0.2mm</p> </div> <p>Total acceptable number: 1/dot, 5/cell (Defect number of (4): 1pc.)</p> </div>
4.	Polarizer Scratches	Not to be conspicuous defects.
5.	Polarizer Dirts	If the stains are removed easily from LCDP surface, the module is not defective.
6.	Complex Foreign Substance Defects	Black spots, line shaped foreign substance or air bubbles between glass & polarizer should be 5pcs maximum in total.
7.	Distance between different Foreign Substance defects	$D \leq 0.2$: 20mm or more $0.2 < D$: 40mm or more

10. Precautions





10.1 Operation



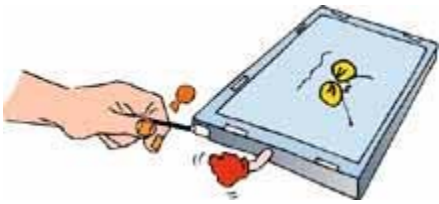

Burn-in sometimes happens when the same character was displayed at along time. Therefore, to prevent Burn-in, it is recommended to set up a Screen-saver function.

10.2 Safety

The liquid crystal in the LCD is poisonous, DO NOT put it in your mouth. If the liquid crystal touches your skin or clothes, wash it off immediately using soap and water.

10.3 Handling

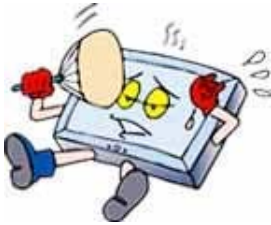
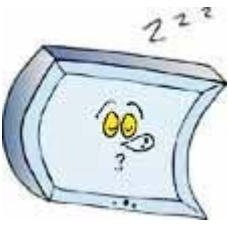
	<p>a. The LCD module shall be installed flat , without twisting or bending.</p> <p>b. COF or FPC has narrow pattern width, so easily become open circuit by external force. DO NOT apply pressure to COF or FPC especially in bending area.</p>
	<p>c. To avoid damage in appearance or malfunction, DO NOT subject the module to mechanical shock or to excessive force on its surface.</p>
	<p>d. The polarizer attached to the display is very easy to damage, handle it with care to avoid scratching</p>
	<p>e. To avoid contamination on the display surface, DO NOT touch the display surface with bare hands.</p> <p>f. Provide a space so that the LCD module does not come into contact with other components components.</p>
	<p>g. To protect the LCD panel from external pressure, put covering glass (acrylic board or similar board) to keep appropriate space between them.</p>

	<p>h. Be careful for condensation at sudden temperature change. Condensation makes damage to polarizer or electrical contacted parts. And after fading condensation, smear or spot will occur.</p>
	<p>i. Property of semiconductor devices may be affected when they are exposed to light possibly resulting in malfunctioning of the ICs. To prevent such malfunctioning of the ICs, your design and mounting layout done are so that the IC is not exposed to light in actual use.</p>
	<p>j. Strong light exposure causes degradation of color filter. It may not recover</p>
	<p>k. DO NOT contact with water to avoid Metal corrosion. l. When it is not in use, the screen must be turned off or the pattern must be frequently changed by a screen saver. If it displays the same pattern for a long period of time, brightness down/image sticking may develop due to the LCD structure.</p>
	<p>m. Never disassemble LCD product under any circumstances. If unqualified operators or users assemble the product after disassembling it, it may not function or its operation may be seriously affected.</p>

10.4 Static electricity

Since a module is composed of electronic circuits, it is not strong to electrostatic discharge.

	<ul style="list-style-type: none"> a. The LCD module shall be installed flat, without wisting or bending. Ground they operate.soldering iron tips, tools and testers when they operat. b. Ground your body when handling the products. c. DO NOT apply voltage to the input terminal without applying power supply. d. DO NOT apply voltage that exceeds the absolute maximum rating. e. Peel off protect tape, attached to polarizer, slowly to minimize ESD damage f. Store the products in an anti-electrostatic container.
---	--

10.5 Storage

	<p>Store the products in a dark place at +5 ~+25℃, low humidity (50%RH or less). DO NOT store the products in an atmosphere containing organic solvents or corrosive gases.</p>
--	---

10.6 Cleaning

	<p>DO NOT wipe the polarizer with dry cloth, as it might cause scratch. Wipe the polarizer with a soft cloth soaked with petroleum IPA, other chemica might damage.</p>
---	---

10.7 Waste

	<p>When dispose of LCD module, manage it at the production waste according to the relevant laws and regulations.</p>
---	--

11. Warranty

This product has been manufactured to your company's specifications as a part for use in your company's general electronic products. It is guaranteed to perform according to delivery specifications. For any other use apart from general electronic equipment, we cannot take responsibility if the product is used in medical devices, nuclear power control equipment, aerospace equipment, fire and security systems, or any other applications in which there is a direct risk to human life and where extremely high levels of reliability are required. If the product is to be used in any of the above applications, we will need to enter into a separate

product liability agreement.

- (1) We cannot accept responsibility for any defect, which may arise from additional manufacturing of the product (including disassembly and reassembly), after product delivery
We cannot accept responsibility for any defect, which may arise after the application of strong
- (2) external force to the product
- (3) We cannot accept responsibility for any defect, which may arise due to the application of static electricity after the product has passed your company's acceptance inspection procedures
- (4) We cannot accept responsibility for industrial property, which may arise through the use of your product, with exception to those issues relating directly to the structure or method of manufacturing of our product. Microtips-origin longer than one year from Microtips production.

Thank you!